

Cover frame

Cover frame, 80mm, 1-gang, white matt

Typ: 1721-884K

Produkt ID: 2CKA001754A4414

GTIN: 4011395128244



Flush mounting cover frame for 1-gang accessories, such as switches. The surface is painted. Cleaning with a mild, standard household detergent. Be careful when cleaning with a powerful dissolvent.

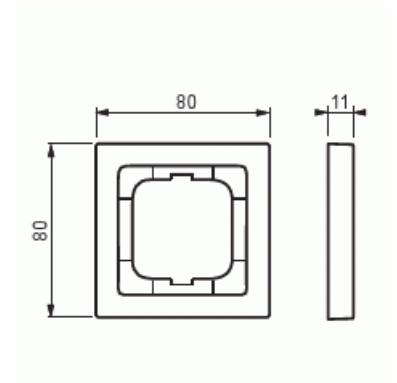

Teknisk specifikation

Packning

Förpackning:	1
Enhet:	st

ETIM Data

ETIM Version:	ETIM-9.0
ETIM Class:	EC000007
Number of units:	1
Mounting direction:	Horizontal and vertical
Number of units horizontal:	1
Number of units vertical:	1
With mounting grid:	Nej
Flush-mounted installation:	Ja

Suitable for floor box:	Nej
Suitable for wall duct:	Ja
Suitable for built-in installation:	Nej
Label space/information surface:	Nej
Material:	Plastic
Material quality:	Thermoplastic
Halogen free:	Ja
Anti-bacterial treatment:	Nej
Surface protection:	Lacquered
Surface finishing:	Matt
Colour:	White
RAL-number (similar):	9016
Transparent:	Nej
With hinged lid:	Nej
Degree of protection (IP):	IP20
Impact strength:	IK03
Type of fastening:	Clamp mounting
Width:	80 mm
Height:	80 mm
Depth:	11 mm
Built-in width:	63 mm
Built-in height:	63 mm
Diameter bore hole (opening):	71 mm