

Cover frame

Cover frame, Carat, 4-gang, Black

Typ: 1724-825

Produkt ID: 2CKA001754A4325

GTIN: 4011395088944



Flush mounting cover frame for 1-gang cover plated accessories, such as switches. Material glass. Cleaning with a mild, standard household detergent. The use of strong dissolvents should be avoided.

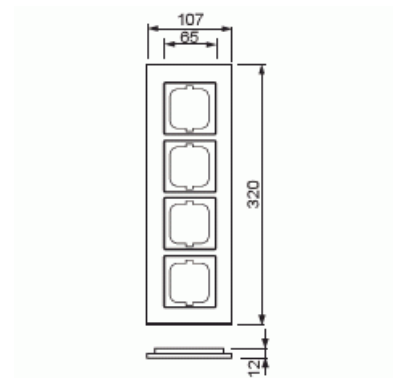

Teknisk specifikation

Klassificering

Enclosure class:	IP20
------------------	------

Colors

Colour:	Black
---------	-------

Packning

Förpackning:	1
Enhet:	st

ETIM Data

ETIM Version:	ETIM-9.0
ETIM Class:	EC000007

Number of units:	4
Mounting direction:	Horizontal and vertical
Number of units horizontal:	4
Number of units vertical:	4
With mounting grid:	Nej
Flush-mounted installation:	Ja
Suitable for floor box:	Nej
Suitable for wall duct:	Ja
Suitable for built-in installation:	Nej
Label space/information surface:	Nej
Material:	Glass
Material quality:	Glass
Halogen free:	Ja
Anti-bacterial treatment:	Nej
Surface protection:	Untreated
Surface finishing:	Glossy
Colour:	Black
Transparent:	Nej
With hinged lid:	Nej
Degree of protection (IP):	IP20
Impact strength:	IK03
Type of fastening:	Clamp mounting
Width:	107 mm
Height:	320 mm
Depth:	11 mm
Built-in width:	63 mm
Built-in height:	63 mm
Diameter bore hole (opening):	71 mm