

Cover frame

Cover frame, Carat, 4-gang, Bronze

Tyyppi: 1724-821

Tuotekoodi: 2CKA001754A4261

GTIN: 4011395056936



Flush mounting cover frame for 1-gang cover plated accessories, such as switches. Suitable for both horizontal and vertical installation. Material bronze casting. Cleaning with a mild, standard neutral household detergent. The patinated surface can be polished with a silver polish, in which case the typical color of bronze is altered temporarily. The use of strong dissolvents should be avoided.

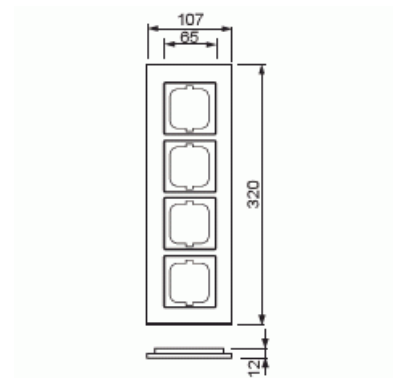

Tekniset tiedot

Pakkaus

Paketti:	1
Yksikkö:	kpl

ETIM Data

ETIM Version:	ETIM-9.0
ETIM Class:	EC000007
Number of units:	4
Mounting direction:	Horizontal and vertical
Number of units horizontal:	4
Number of units vertical:	4
With mounting grid:	Ei

Flush-mounted installation:	Kyllä
Suitable for floor box:	Ei
Suitable for wall duct:	Kyllä
Suitable for built-in installation:	Ei
Label space/information surface:	Ei
Material:	Other
Material quality:	Other
Halogen free:	Kyllä
Anti-bacterial treatment:	Ei
Surface protection:	Sand-cast
Surface finishing:	Matt
Colour:	Bronze
Transparent:	Ei
With hinged lid:	Ei
Degree of protection (IP):	IP20
Impact strength:	IK03
Type of fastening:	Clamp mounting
Width:	107 mm
Height:	320 mm
Depth:	11 mm
Built-in width:	63 mm
Built-in height:	63 mm
Diameter bore hole (opening):	71 mm